

Rev	Date	By
I	1-7-2019	RBO
J	27-10-2021	RBO
K	19-9-2024	RBO
L	14-4-2026	RBO
M	30-4-2026	RBO

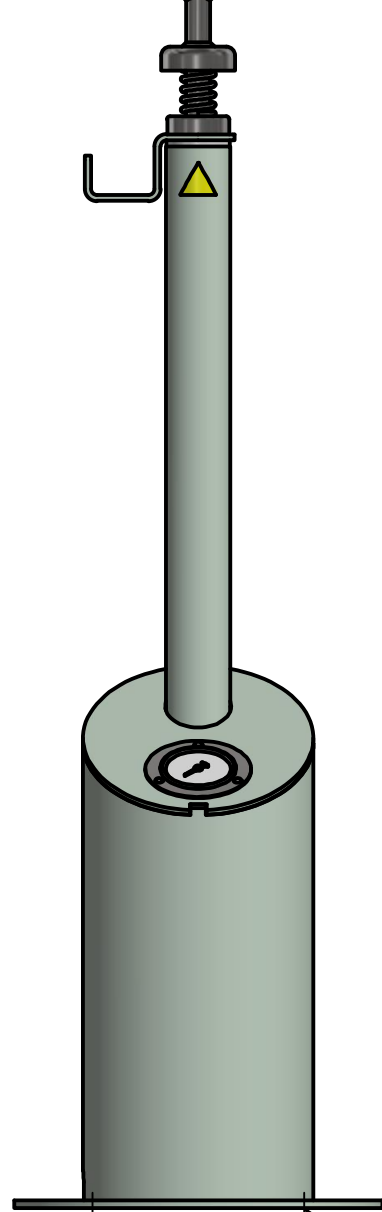

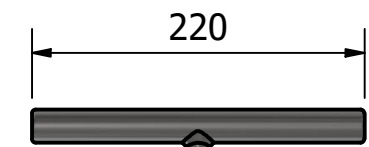

140 4x Ø15

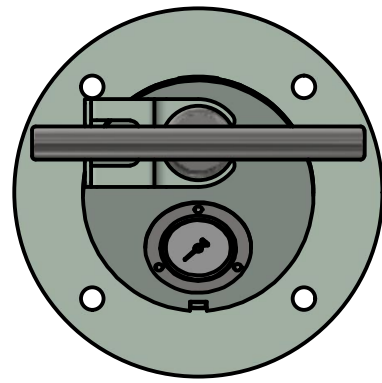
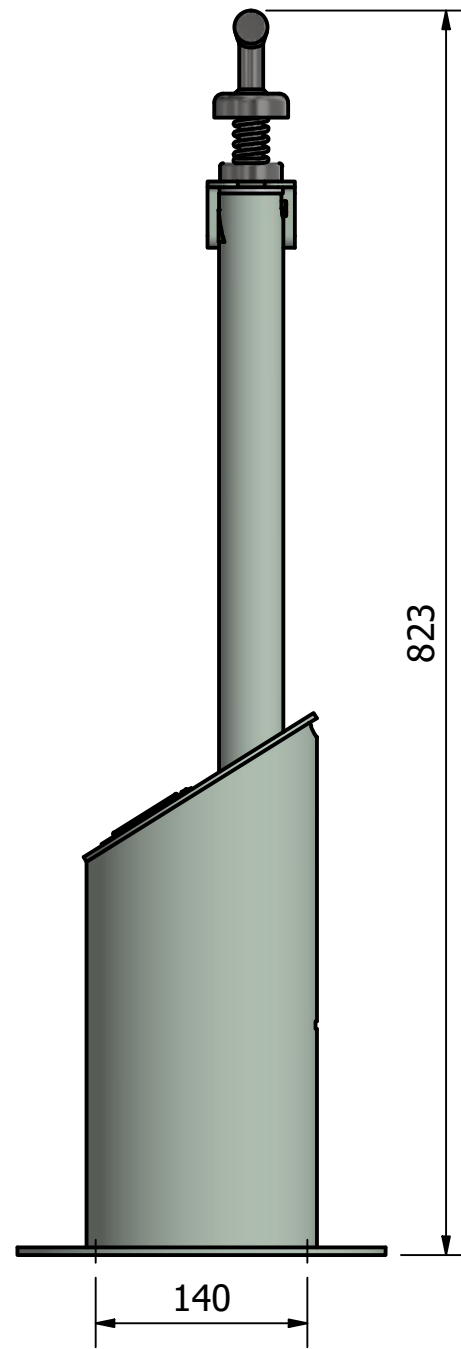

823

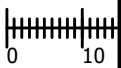
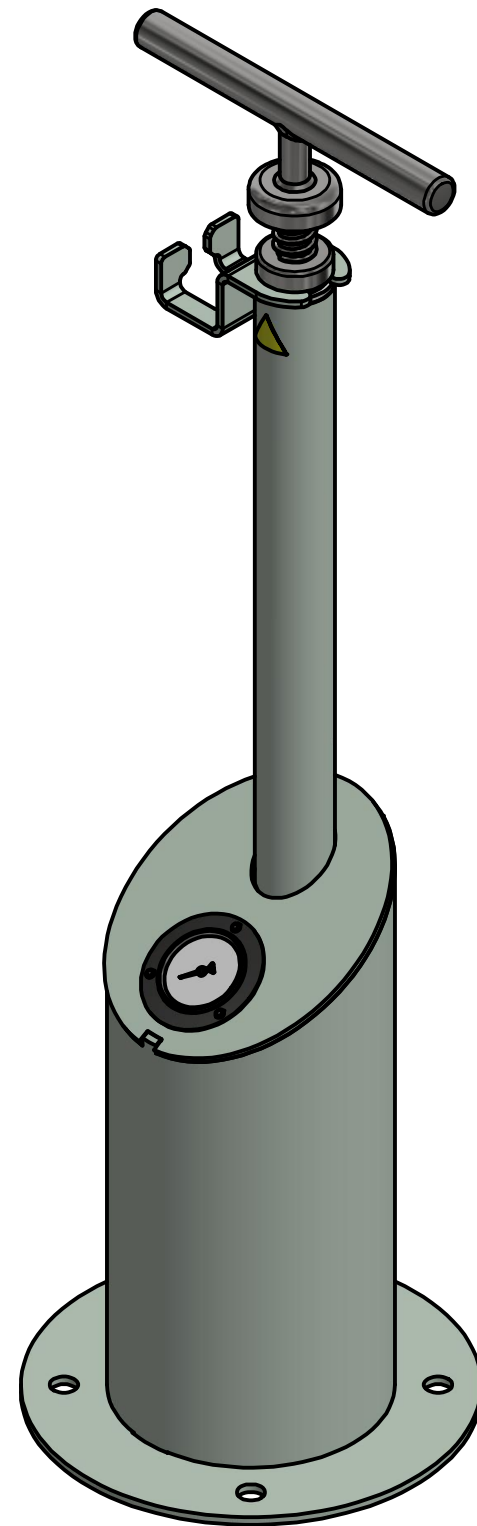
140



 Falco BV Postbus 18 7670AA Vriezenveen	T +31 (0)546 55 44 44 F +31 (0)546 56 11 15 I www.falco.nl	Item number: 01.962.000	Revision: M
		Title: FalcoFiks 2.0 fietspomp op vp	Format: A3
Drawn by: RBO	Drawing unit: mm		
Date: 17-11-2016	Scale: 1 : 5		
Document No.: E0030641.dwg M	Page: 1 / 1		